

MG TORK

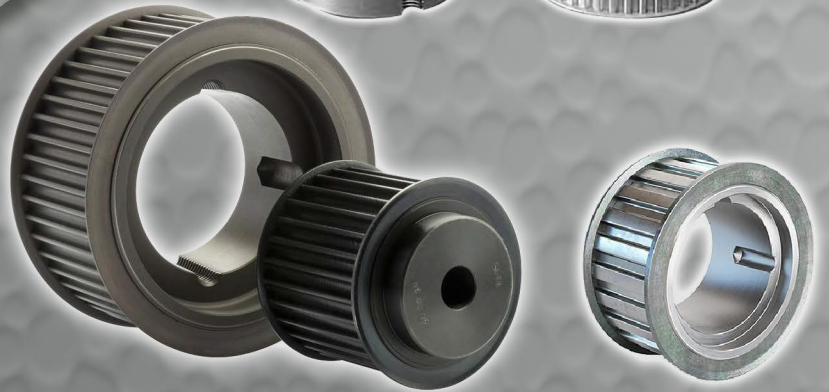

TRİGER KASNAKLAR
Timing Belt Pulleys
www.mgtork.com

HTD TRİGER KASNAKLAR
HTD Timing Belt Pulleys

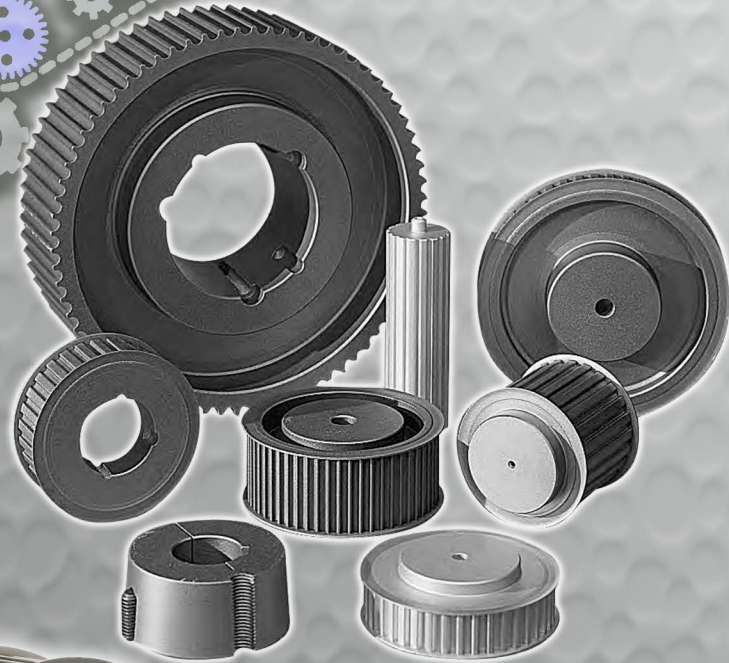
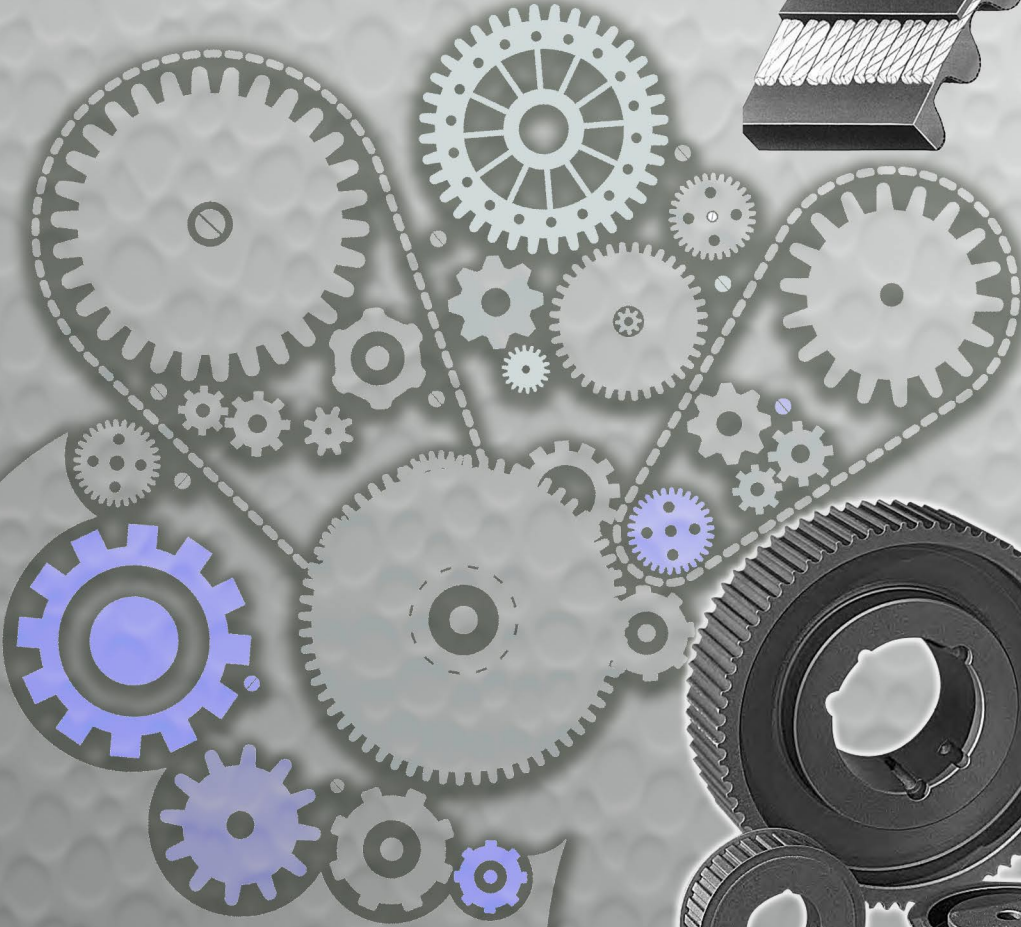
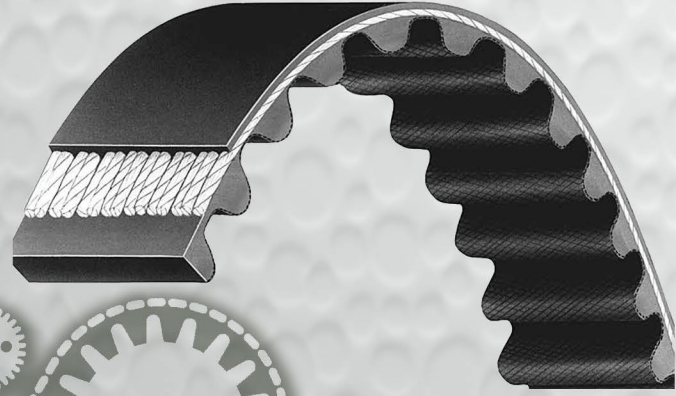

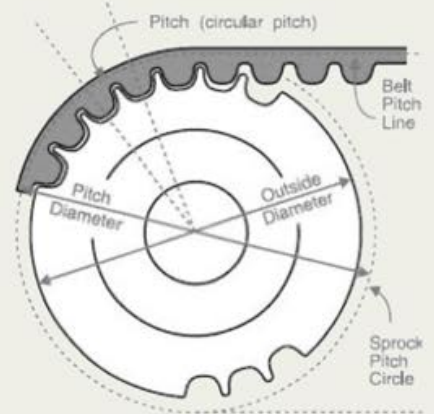
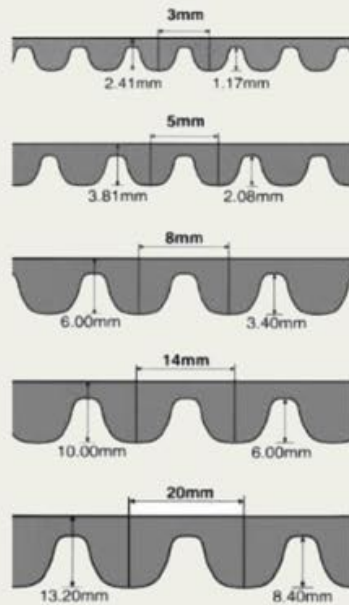
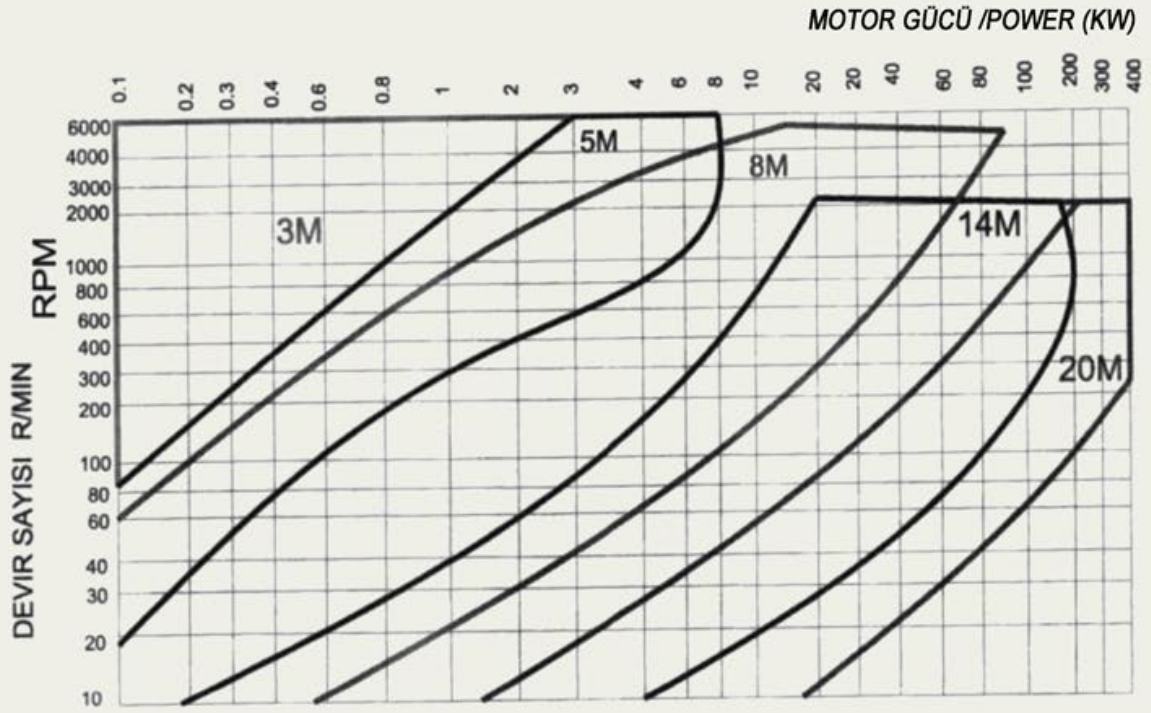

PİLOT DELİKLİ / Pilot Bore

3M09

3M09 Kayış Geniřlięi 0,9 mm Belt Width 0,9 mm								
Diř SAYISI Number	ÇAP Diameter		TİP Type	DELİK Bore		BOYUTLAR Dimensions		
	PD.	A		Min.	Max.	H	F	L
	mm	mm		mm	mm	mm	mm	mm
10	9,55	13,0	0F	-	4,0	13,0	10,2	17,5
12	11,46	15,0	0F	-	6,0	15,0	10,2	17,5
14	13,37	16,0	0F	-	7,0	16,0	10,2	17,5
15	14,32	17,5	0F	-	8,0	17,5	10,2	17,5
16	15,28	18,0	0F	4,0	6,0	10,0	10,2	17,5
18	17,19	19,5	1F	6,0	6,5	11,0	10,2	17,5
20	19,1	23,0	1F	6,0	8,0	13,0	10,2	17,5
21	20,05	25,0	1F	6,0	8,5	14,0	10,2	17,5
22	21,01	25,0	1F	6,0	8,5	14,0	10,2	17,5
24	22,92	25,0	1F	6,0	8,5	14,0	10,2	17,5
26	24,83	28,0	1F	6,0	10,5	16,0	10,2	17,5
28	26,74	32,0	1F	6,0	11,5	18,0	10,2	17,5
30	28,65	32,0	1F	6,0	12,5	20,0	10,2	17,5
32	30,56	36,0	1F	6,0	14,0	22,0	10,2	17,5
36	34,38	38,0	1F	6,0	17,0	26,0	10,2	17,5
40	38,2	42,0	1F	6,0	19,0	28,0	10,2	17,5
44	42,02	48,0	1F	6,0	22,5	33,0	10,2	17,5
48	45,84	-	1	8,0	22,5	33,0	10,2	17,5
60	57,3	-	1	8,0	22,5	33,0	10,2	17,5
72	68,75	-	1	8,0	22,5	33,0	10,2	17,5

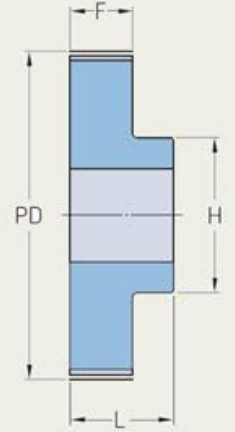
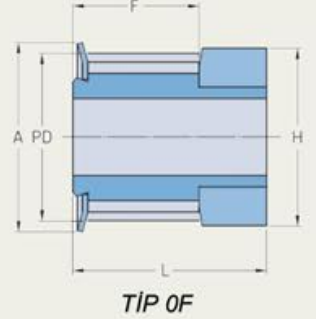

3M15

3M15 Kayış Geniřlięi 15 mm Belt Width 15 mm								
Diř SAYISI Number	ÇAP Diameter		TİP Type	DELİK Bore		BOYUTLAR Dimensions		
	PD.	A		Min.	Max.	H	F	L
	mm	mm		mm	mm	mm	mm	mm
10	9,55	13,0	0F	-	4,0	13,0	17,0	26,0
12	11,46	15,0	0F	-	6,0	15,0	17,0	26,0
14	13,37	16,0	0F	-	7,0	16,0	17,0	26,0
15	14,32	17,5	0F	-	8,0	17,5	17,0	26,0
16	15,28	18,0	0F	4,0	6,0	10,0	17,0	26,0
18	17,19	19,5	1F	6,0	6,5	11,0	17,0	26,0
20	19,1	23,0	1F	6,0	8,0	13,0	17,0	26,0
21	20,05	25,0	1F	6,0	8,5	14,0	17,0	26,0
22	21,01	25,0	1F	6,0	8,5	14,0	17,0	26,0
24	22,92	25,0	1F	6,0	8,5	14,0	17,0	26,0
26	24,83	28,0	1F	6,0	10,5	16,0	17,0	26,0
28	26,74	32,0	1F	6,0	11,5	18,0	17,0	26,0
30	28,65	32,0	1F	6,0	12,5	20,0	17,0	26,0
32	30,56	36,0	1F	6,0	14,0	22,0	17,0	26,0
36	34,38	38,0	1F	6,0	17,0	26,0	17,0	26,0
40	38,2	42,0	1F	6,0	19,0	28,0	17,0	26,0
44	42,02	48,0	1F	6,0	22,5	33,0	17,0	26,0
48	45,84	-	1	8,0	22,5	33,0	17,0	26,0
60	57,3	-	1	8,0	22,5	33,0	17,0	26,0
72	68,75	-	1	8,0	22,5	33,0	17,0	26,0

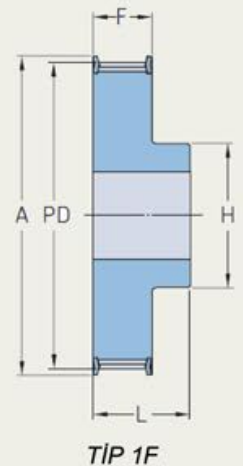

PILOT DELİKLİ / Pilot Bore

5M09

5M09			Kayış Geniřlięi 0,9 mm Belt Width 0,9 mm					
DIŐ SAYISI Number	ÇAP Diameter		TİP Type	DELİK Bore		BOYUTLAR Dimensions		
	PD.	A		Min.	Max.	H	F	L
	mm	mm		mm	mm	mm	mm	mm
12	19,10	25,0	1F	4,0	8,0	13,0	14,5	20,0
14	22,28	25,0	1F	6,0	9,0	13,0	14,5	20,0
15	23,87	28,0	1F	6,0	11,0	16,0	14,5	20,0
16	25,46	28,0	1F	6,0	11,0	16,0	14,5	20,0
18	28,65	32,0	1F	6,0	13,0	19,0	14,5	20,0
20	31,83	36,0	1F	6,0	14,0	23,0	14,5	22,5
21	33,42	38,0	1F	6,0	15,0	24,0	14,5	22,5
22	35,01	38,0	1F	6,0	16,0	25,5	14,5	22,5
24	38,20	42,0	1F	6,0	18,0	27,0	14,5	22,5
26	41,38	44,0	1F	6,0	20,0	30,0	14,5	22,5
28	44,56	48,0	1F	6,0	20,0	30,5	14,5	22,5
30	47,75	51,0	1F	6,0	24,0	35,0	14,5	22,5
32	50,93	54,0	1F	8,0	26,0	38,0	14,5	22,5
36	57,30	60,0	1F	8,0	26,0	38,0	14,5	22,5
40	63,66	71,0	1F	8,0	26,0	38,0	14,5	22,5
44	70,03	48,0	2	8,0	26,0	38,0	14,5	25,5
48	76,39	-	2	8,0	26,0	38,0	14,5	25,5
60	95,49	-	2	8,0	30,0	45,0	14,5	25,5
72	114,59	-	2	8,0	30,0	45,0	14,5	25,5

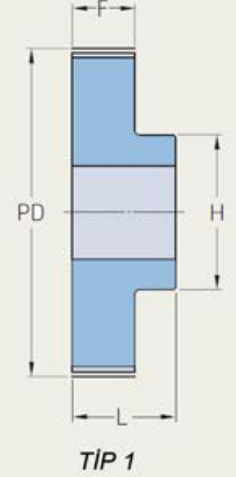

5M15

5M15			Kayış Geniřlięi 15 mm Belt Width 15 mm					
DIŐ SAYISI Number	ÇAP Diameter		TİP Type	DELİK Bore		BOYUTLAR Dimensions		
	PD.	A		Min.	Max.	H	F	L
	mm	mm		mm	mm	mm	mm	mm
12	19,10	25,0	1F	4,0	8,0	13,0	20,5	26,0
14	22,28	25,0	1F	6,0	9,0	13,0	20,5	26,0
15	23,87	28,0	1F	6,0	11,0	16,0	20,5	26,0
16	25,46	28,0	1F	6,0	11,0	16,0	20,5	26,0
18	28,65	32,0	1F	6,0	13,0	19,0	20,5	26,0
20	31,83	36,0	1F	6,0	14,0	23,0	20,5	26,0
21	33,42	38,0	1F	6,0	15,0	24,0	20,5	26,0
22	35,01	38,0	1F	6,0	16,0	25,5	20,5	26,0
24	38,20	42,0	1F	6,0	18,0	27,0	20,5	28,0
26	41,38	44,0	1F	6,0	20,0	30,0	20,5	28,0
28	44,56	48,0	1F	6,0	20,0	30,5	20,5	28,0
30	47,75	51,0	1F	6,0	24,0	35,0	20,5	28,0
32	50,93	54,0	1F	8,0	26,0	38,0	20,5	28,0
36	57,30	60,0	1F	8,0	26,0	38,0	20,5	28,0
40	63,66	71,0	1F	8,0	26,0	38,0	20,5	28,0
44	70,03	48,0	2	8,0	26,0	38,0	20,5	30,0
48	76,39	-	2	8,0	26,0	38,0	20,5	30,0
60	95,49	-	2	8,0	30,0	50,0	20,5	30,0
72	114,59	-	2	8,0	30,0	50,0	20,5	30,0

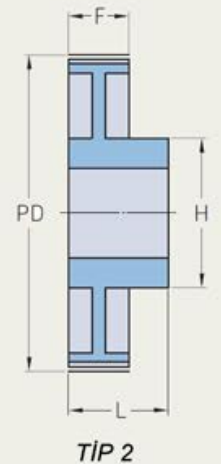
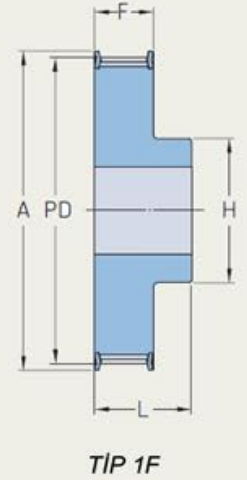

PİLOT DELİKLİ / Pilot Bore

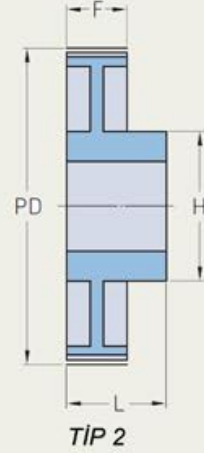
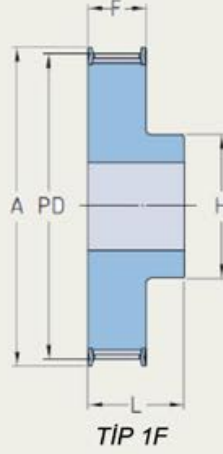
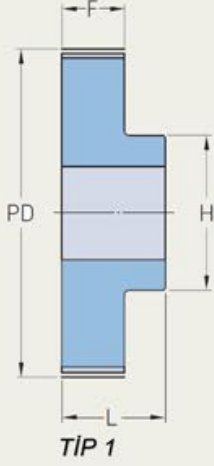

5M25

5M25		Kayış Geniřlięi 25 mm Belt Width 25 mm						
DİŐ SAYISI Number	ÇAP Diameter		TİP Type	DELİK Bore		BOYUTLAR Dimensions		
	PD.	A		Min.	Max.	H	F	L
	mm	mm		mm	mm	mm	mm	mm
12	19,10	25,0	1F	4,0	8,0	13,0	30,5	36,0
14	22,28	25,0	1F	6,0	9,0	13,0	30,5	36,0
15	23,87	28,0	1F	6,0	11,0	16,0	30,5	36,0
16	25,46	28,0	1F	6,0	11,0	16,0	30,5	36,0
18	28,65	32,0	1F	6,0	13,0	19,0	30,5	36,0
20	31,83	36,0	1F	6,0	14,0	23,0	30,5	36,0
21	33,42	38,0	1F	6,0	15,0	24,0	30,5	38,0
22	35,01	38,0	1F	6,0	16,0	25,5	30,5	38,0
24	38,20	42,0	1F	6,0	18,0	27,0	30,5	38,0
26	41,38	44,0	1F	6,0	20,0	30,0	30,5	38,0
28	44,56	48,0	1F	6,0	20,0	30,5	30,5	38,0
30	47,75	51,0	1F	6,0	24,0	35,0	30,5	38,0
32	50,93	54,0	1F	8,0	26,0	38,0	30,5	38,0
36	57,30	60,0	1F	8,0	26,0	38,0	30,5	38,0
40	63,66	71,0	1F	8,0	26,0	38,0	30,5	38,0
44	70,03	-	2	8,0	26,0	38,0	30,5	40,0
48	76,39	-	2	8,0	26,0	38,0	30,5	40,0
60	95,49	-	2	8,0	34,0	50,0	30,5	40,0
72	114,59	-	2	8,0	34,0	50,0	30,5	40,0
80	127,32	-	2	8,0	40,0	50,0	30,5	40,0

PİLOT DELİKLİ / Pilot Bore

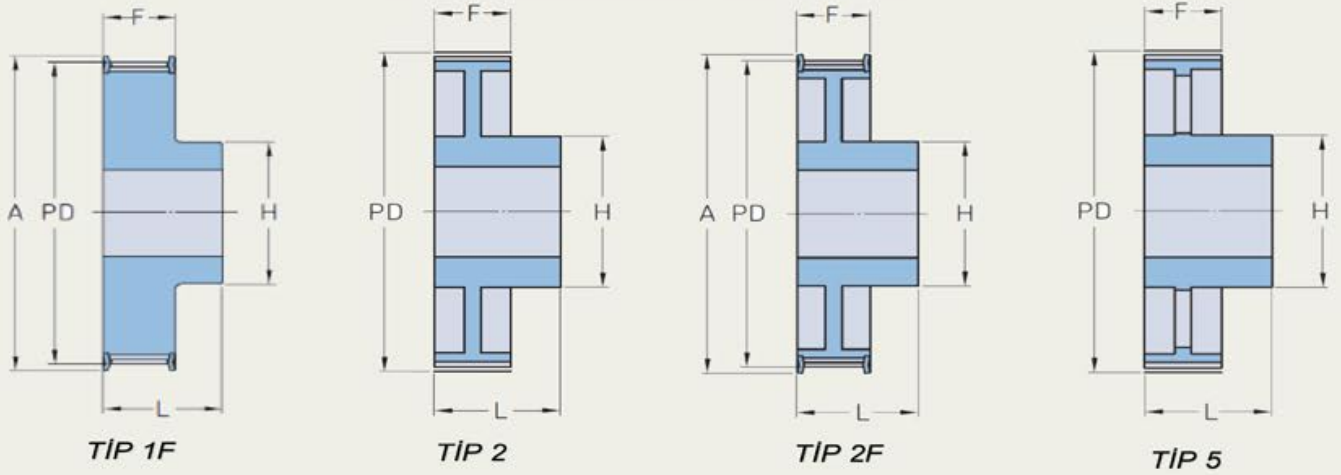

8M20

8M20		Kayış Geniřliđi 20 mm Belt Width 20 mm						
DİŐ SAYISI Number	ÇAP Diameter		TİP Type	DELİK Bore		BOYUTLAR Dimensions		
	PD. mm	A mm		Min. mm	Max. mm	H mm	F mm	L mm
20	50,93	60,0	1F	12,0	25,0	38,0	28,0	38,0
21	53,47	62,0	1F	12,0	27,0	40,0	28,0	38,0
22	56,02	65,0	1F	12,0	29,0	43,0	28,0	38,0
23	58,57	65,0	1F	12,0	29,0	45,0	28,0	38,0
24	61,12	70,0	1F	12,0	30,0	45,0	28,0	38,0
25	63,66	71,0	1F	12,0	31,0	45,0	28,0	38,0
26	66,21	75,0	1F	12,0	32,0	50,0	28,0	38,0
27	68,75	75,0	1F	12,0	33,0	50,0	28,0	38,0
28	71,30	80,0	1F	15,0	34,0	50,0	28,0	38,0
29	73,85	85,0	1F	15,0	35,0	55,0	28,0	38,0
30	76,39	85,0	1F	15,0	36,0	55,0	28,0	38,0
31	78,94	87,0	1F	15,0	38,0	55,0	28,0	38,0
32	81,49	90,0	1F	15,0	40,0	60,0	28,0	38,0
33	84,03	90,0	1F	15,0	42,0	60,0	28,0	38,0
34	86,58	95,0	1F	15,0	44,0	70,0	28,0	38,0
35	89,13	95,0	1F	15,0	45,0	70,0	28,0	38,0
36	91,67	100,0	1F	15,0	46,0	70,0	28,0	38,0
38	96,77	105,0	1F	15,0	50,0	75,0	28,0	38,0
40	101,86	110,0	1F	15,0	50,0	75,0	28,0	38,0
42	106,95	111,0	1F	15,0	50,0	75,0	28,0	38,0
44	112,05	121,0	1F	15,0	50,0	75,0	28,0	38,0
45	114,59	121,0	1F	15,0	50,0	75,0	28,0	38,0
48	122,23	131,0	1F	15,0	54,0	75,0	28,0	38,0
50	127,32	131,0	1F	15,0	54,0	75,0	28,0	38,0
52	132,42	140,0	1F	15,0	54,0	80,0	28,0	38,0
56	142,60	151,0	2F	15,0	54,0	80,0	28,0	38,0
64	162,97	172,0	2F	15,0	54,0	80,0	28,0	38,0
72	183,35	192,0	2F	15,0	54,0	80,0	28,0	38,0
80	203,72	-	2	15,0	54,0	80,0	28,0	38,0
90	229,18	-	2	15,0	54,0	90,0	28,0	38,0
112	285,21	-	5	18,0	54,0	90,0	28,0	38,0
144	366,69	-	5	20,0	54,0	90,0	28,0	38,0
168	427,81	-	5	20,0	60,0	100,0	28,0	38,0
192	488,92	-	5	20,0	60,0	100,0	28,0	38,0

PİLOT DELİKLİ / Pilot Bore

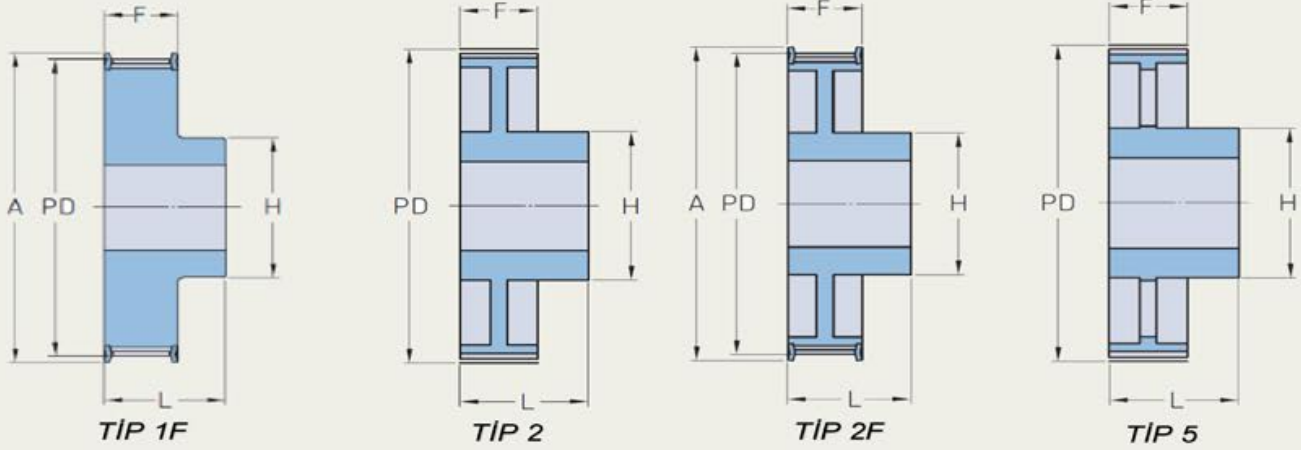

8M30

8M30			Kayış Geniřliđi 30 mm Belt Width 30 mm					
DİŐ SAYISI Number	ÇAP Diameter		TİP Type	DELİK Bore		BOYUTLAR Dimensions		
	PD.	A		Min.	Max.	H	F	L
	mm	mm		mm	mm	mm	mm	mm
20	50,93	60,0	1F	12,0	25,0	38,0	38,0	48,0
21	53,47	62,0	1F	12,0	27,0	40,0	38,0	48,0
22	56,02	65,0	1F	12,0	29,0	43,0	38,0	48,0
23	58,57	65,0	1F	12,0	29,0	45,0	38,0	48,0
24	61,12	70,0	1F	12,0	30,0	45,0	38,0	48,0
25	63,66	71,0	1F	12,0	31,0	45,0	38,0	48,0
26	66,21	75,0	1F	12,0	32,0	50,0	38,0	48,0
27	68,75	75,0	1F	12,0	33,0	50,0	38,0	48,0
28	71,30	80,0	1F	15,0	34,0	50,0	38,0	48,0
29	73,85	85,0	1F	15,0	35,0	55,0	38,0	48,0
30	76,39	85,0	1F	15,0	36,0	55,0	38,0	48,0
31	78,94	87,0	1F	15,0	38,0	55,0	38,0	48,0
32	81,49	90,0	1F	15,0	40,0	60,0	38,0	48,0
33	84,03	90,0	1F	15,0	42,0	60,0	38,0	48,0
34	86,58	95,0	1F	15,0	44,0	70,0	38,0	48,0
35	89,13	95,0	1F	15,0	45,0	70,0	38,0	48,0
36	91,67	100,0	1F	15,0	46,0	70,0	38,0	48,0
38	96,77	105,0	1F	15,0	50,0	75,0	38,0	48,0
40	101,86	110,0	1F	15,0	50,0	75,0	38,0	48,0
42	106,95	111,0	1F	15,0	50,0	75,0	38,0	48,0
44	112,05	121,0	1F	15,0	50,0	75,0	38,0	48,0
45	114,59	121,0	1F	15,0	50,0	75,0	38,0	48,0
48	122,23	131,0	1F	15,0	54,0	75,0	38,0	48,0
50	127,32	131,0	1F	15,0	54,0	90,0	38,0	48,0
52	132,42	140,0	1F	15,0	54,0	90,0	38,0	48,0
56	142,60	151,0	2F	15,0	54,0	90,0	38,0	48,0
64	162,97	172,0	2F	15,0	54,0	90,0	38,0	48,0
72	183,35	192,0	2F	15,0	54,0	95,0	38,0	48,0
80	203,72	-	2	15,0	54,0	100,0	38,0	48,0
90	229,18	-	2	15,0	54,0	100,0	38,0	48,0
112	285,21	-	5	18,0	54,0	100,0	38,0	48,0
144	366,69	-	5	20,0	54,0	100,0	38,0	48,0
168	427,81	-	5	20,0	60,0	100,0	38,0	48,0
192	488,92	-	5	20,0	60,0	100,0	38,0	48,0



PİLOT DELİKLİ / Pilot Bore

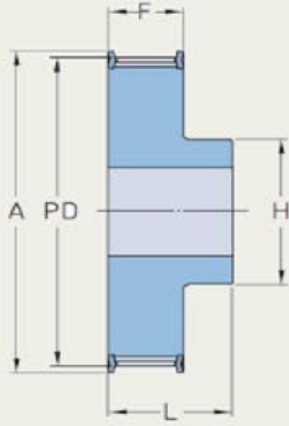

TIP 1F

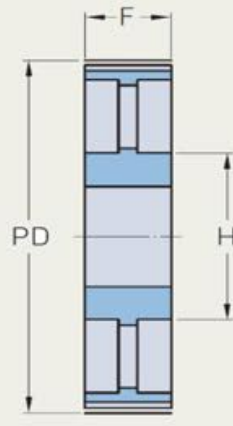

TIP 3

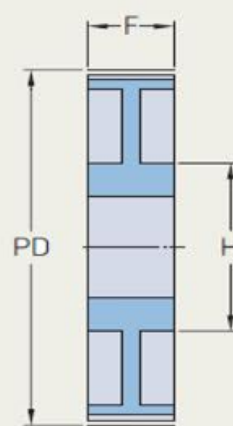

TIP 7

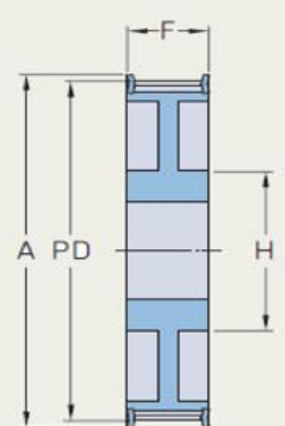

TIP 7F

8M50

8M50		Kayış Geniřlięi 50 mm Belt Width 50 mm						
Diř SAYISI Number	ÇAP Diameter		TİP Type	DELİK Bore		BOYUTLAR Dimensions		
	PD. mm	A mm		Min. mm	Max. mm	H mm	F mm	L mm
22	56,02	65,0	1F	12,0	29,0	43,0	60,0	70,0
23	58,57	65,0	1F	12,0	29,0	45,0	60,0	70,0
24	61,12	70,0	1F	12,0	30,0	45,0	60,0	70,0
25	63,66	71,0	1F	12,0	31,0	45,0	60,0	70,0
26	66,21	75,0	1F	12,0	32,0	50,0	60,0	70,0
27	68,75	75,0	1F	12,0	33,0	50,0	60,0	70,0
28	71,30	80,0	1F	15,0	34,0	50,0	60,0	70,0
29	73,85	85,0	1F	15,0	35,0	55,0	60,0	70,0
30	76,39	85,0	1F	15,0	36,0	55,0	60,0	70,0
31	78,94	87,0	1F	15,0	38,0	55,0	60,0	70,0
32	81,49	90,0	1F	15,0	40,0	60,0	60,0	70,0
33	84,03	90,0	1F	15,0	42,0	60,0	60,0	70,0
34	86,58	95,0	1F	15,0	44,0	70,0	60,0	70,0
35	89,13	95,0	1F	15,0	45,0	70,0	60,0	70,0
36	91,67	100,0	1F	15,0	46,0	70,0	60,0	70,0
38	96,77	105,0	1F	15,0	50,0	75,0	60,0	70,0
40	101,86	110,0	1F	18,0	50,0	75,0	60,0	70,0
42	106,95	111,0	1F	18,0	50,0	75,0	60,0	70,0
44	112,05	121,0	1F	18,0	50,0	75,0	60,0	70,0
45	114,59	121,0	1F	18,0	50,0	75,0	60,0	70,0
48	122,23	131,0	1F	18,0	54,0	80,0	60,0	70,0
50	127,32	131,0	1F	18,0	54,0	80,0	60,0	70,0
52	132,42	140,0	1F	18,0	54,0	90,0	60,0	70,0
56	142,60	151,0	7F	18,0	54,0	90,0	60,0	70,0
60	152,79	158,0	7F	18,0	54,0	90,0	60,0	70,0
64	162,97	172,0	7F	18,0	54,0	100,0	60,0	70,0
72	183,35	192,0	7F	18,0	54,0	100,0	60,0	70,0
80	203,72	-	7	18,0	54,0	110,0	60,0	70,0
90	229,18	-	7	18,0	54,0	110,0	60,0	70,0
112	285,21	-	3	20,0	54,0	110,0	60,0	70,0
144	366,69	-	3	20,0	54,0	110,0	60,0	70,0
168	427,81	-	3	20,0	60,0	120,0	60,0	70,0
192	488,92	-	3	20,0	60,0	130,0	60,0	70,0

PİLOT DELİKLİ / Pilot Bore

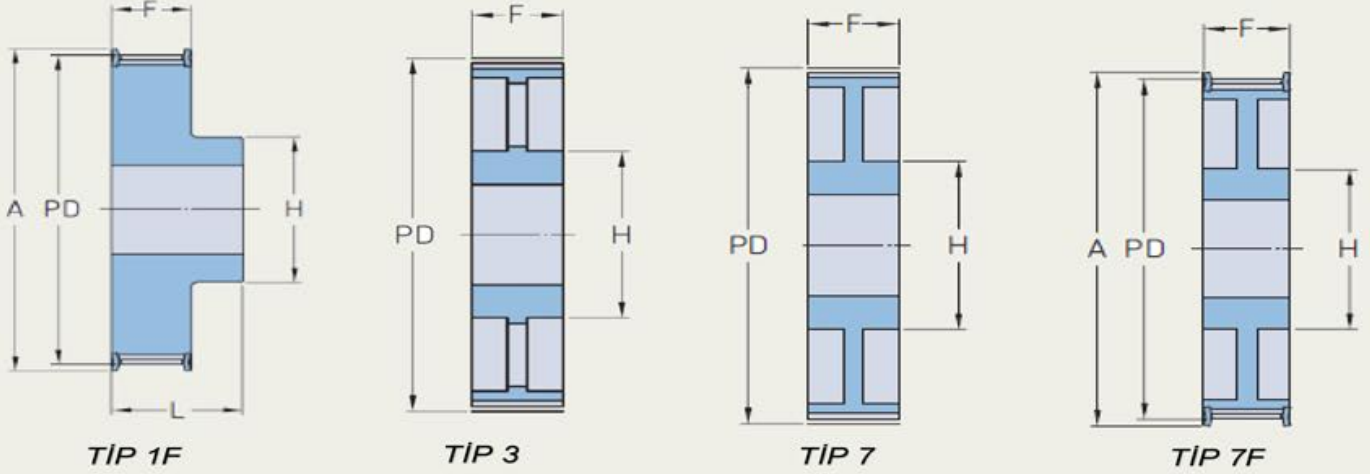

8M85

8M85			Kayış Geniřliđi 85 mm Belt Width 85 mm					
DİŐ SAYISI Number	ÇAP Diameter		TİP Type	DELİK Bore		BOYUTLAR Dimensions		
	PD.	A		Min.	Max.	H	F	L
	mm	mm		mm	mm	mm	mm	mm
22	56,02	65,0	1F	12,0	29,0	43,0	95,0	105,0
23	58,57	65,0	1F	12,0	29,0	45,0	95,0	105,0
24	61,12	70,0	1F	12,0	30,0	45,0	95,0	105,0
25	63,66	71,0	1F	12,0	31,0	45,0	95,0	105,0
26	66,21	75,0	1F	12,0	32,0	50,0	95,0	105,0
27	68,75	75,0	1F	12,0	33,0	50,0	95,0	105,0
28	71,30	80,0	1F	15,0	34,0	50,0	95,0	105,0
29	73,85	85,0	1F	15,0	35,0	55,0	95,0	105,0
30	76,39	85,0	1F	15,0	36,0	55,0	95,0	105,0
31	78,94	87,0	1F	15,0	38,0	55,0	95,0	105,0
32	81,49	90,0	1F	15,0	40,0	60,0	95,0	105,0
33	84,03	90,0	1F	15,0	42,0	60,0	95,0	105,0
34	86,58	95,0	1F	15,0	44,0	70,0	95,0	105,0
35	89,13	95,0	1F	15,0	45,0	70,0	95,0	105,0
36	91,67	100,0	1F	15,0	46,0	70,0	95,0	105,0
38	96,77	105,0	1F	15,0	50,0	75,0	95,0	105,0
40	101,86	110,0	1F	18,0	50,0	75,0	95,0	105,0
42	106,95	111,0	1F	18,0	50,0	75,0	95,0	105,0
44	112,05	121,0	1F	18,0	50,0	75,0	95,0	105,0
45	114,59	121,0	1F	18,0	50,0	75,0	95,0	105,0
48	122,23	131,0	1F	18,0	54,0	80,0	95,0	105,0
50	127,32	131,0	1F	18,0	54,0	80,0	95,0	105,0
52	132,42	140,0	1F	18,0	54,0	90,0	95,0	105,0
56	142,60	151,0	1F	18,0	54,0	90,0	95,0	105,0
60	152,79	158,0	7F	18,0	54,0	90,0	95,0	105,0
64	162,97	172,0	7F	18,0	54,0	100,0	95,0	105,0
72	183,35	192,0	7F	18,0	54,0	100,0	95,0	105,0
80	203,72	-	3	18,0	54,0	110,0	95,0	105,0
90	229,18	-	3	18,0	54,0	110,0	95,0	105,0
112	285,21	-	3	20,0	54,0	110,0	95,0	105,0
144	366,69	-	3	20,0	54,0	110,0	95,0	105,0
168	427,81	-	3	20,0	60,0	120,0	95,0	105,0
192	488,92	-	3	20,0	60,0	130,0	95,0	105,0

PİLOT DELİKLİ / Pilot Bore

14M40

14M40			Kayış Geniřliđi 40 mm Belt Width 40 mm					
DİŐ SAYISI Number	ÇAP Diameter		TİP Type	DELİK Bore		BOYUTLAR Dimensions		
	PD. mm	A mm		Min. mm	Max. mm	H mm	F mm	L mm
28	124,78	127,0	1F	24,0	67,0	100,0	54,0	69,0
29	129,23	138,0	1F	24,0	67,0	100,0	54,0	69,0
30	133,69	138,0	1F	24,0	67,0	100,0	54,0	69,0
32	142,60	154,0	1F	24,0	67,0	100,0	54,0	69,0
34	151,52	160,0	1F	24,0	67,0	100,0	54,0	69,0
36	160,43	168,0	1F	24,0	67,0	100,0	54,0	69,0
38	169,34	183,0	1F	24,0	80,0	120,0	54,0	69,0
40	178,25	188,0	1F	24,0	80,0	120,0	54,0	69,0
44	196,08	211,0	1F	24,0	80,0	120,0	54,0	69,0
48	213,90	226,0	2F	24,0	82,0	135,0	54,0	69,0
56	249,55	256,0	2F	28,0	82,0	135,0	54,0	69,0
64	285,21	296,0	2F	28,0	82,0	135,0	54,0	69,0
72	320,86	-	5	28,0	82,0	135,0	54,0	69,0
80	356,51	-	5	28,0	82,0	135,0	54,0	69,0
90	401,07	-	5	28,0	82,0	135,0	54,0	69,0
112	499,11	-	5	28,0	82,0	135,0	54,0	69,0
144	641,71	-	5	28,0	82,0	135,0	54,0	69,0
168	748,66	-	5	28,0	82,0	135,0	54,0	69,0
192	855,62	-	5	28,0	82,0	135,0	54,0	69,0
216	962,57	-	5	28,0	90,0	150,0	54,0	69,0

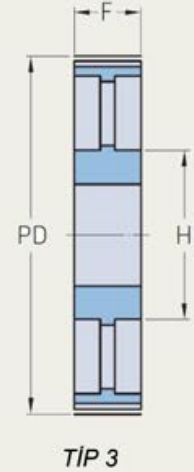
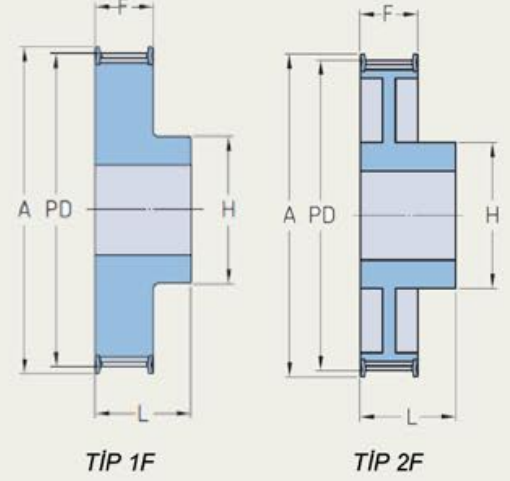

14M55

14M55			Kayış Geniřliđi 55 mm Belt Width 55 mm					
DİŐ SAYISI Number	ÇAP Diameter		TİP Type	DELİK Bore		BOYUTLAR Dimensions		
	PD. mm	A mm		Min. mm	Max. mm	H mm	F mm	L mm
28	124,78	127,0	1F	24,0	67,0	100,0	70,0	85,0
29	129,23	138,0	1F	24,0	67,0	100,0	70,0	85,0
30	133,69	138,0	1F	24,0	67,0	100,0	70,0	85,0
32	142,60	154,0	1F	24,0	67,0	100,0	70,0	85,0
34	151,52	160,0	1F	24,0	67,0	100,0	70,0	85,0
36	160,43	168,0	1F	24,0	67,0	100,0	70,0	85,0
38	169,34	183,0	1F	24,0	80,0	120,0	70,0	85,0
40	178,25	188,0	1F	24,0	80,0	120,0	70,0	85,0
44	196,08	211,0	1F	24,0	80,0	120,0	70,0	85,0
48	213,90	226,0	7F	24,0	82,0	135,0	70,0	85,0
56	249,55	256,0	7F	28,0	82,0	135,0	70,0	85,0
64	285,21	296,0	7F	28,0	82,0	135,0	70,0	85,0
72	320,86	-	3	28,0	82,0	135,0	70,0	85,0
80	356,51	-	3	28,0	82,0	135,0	70,0	85,0
90	401,07	-	3	28,0	82,0	135,0	70,0	85,0
112	499,11	-	3	28,0	82,0	135,0	70,0	85,0
144	641,71	-	3	28,0	82,0	135,0	70,0	85,0
168	748,66	-	3	28,0	82,0	135,0	70,0	85,0
192	855,62	-	3	28,0	82,0	135,0	70,0	85,0
216	962,57	-	3	28,0	90,0	150,0	70,0	85,0

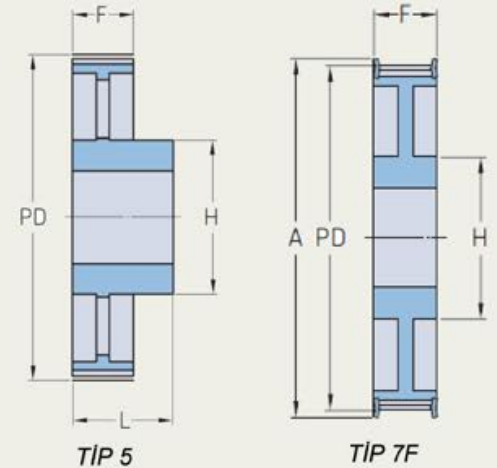

PİLOT DELİKLİ / Pilot Bore

14M85

14M85 Kayış Geniřlięi 85 mm Belt Width 85 mm								
DİŐ SAYISI Number	ÇAP Diameter		TİP Type	DELİK Bore		BOYUTLAR Dimensions		
	PD.	A		Min.	Max.	H	F	L
	mm	mm		mm	mm	mm	mm	mm
28	124,78	127,0	1F	24,0	67,0	100,0	102,0	117,0
29	129,23	138,0	1F	24,0	67,0	100,0	102,0	117,0
30	133,69	138,0	1F	24,0	67,0	100,0	102,0	117,0
32	142,60	154,0	1F	24,0	67,0	100,0	102,0	117,0
34	151,52	160,0	1F	24,0	67,0	100,0	102,0	117,0
36	160,43	168,0	1F	24,0	67,0	100,0	102,0	117,0
38	169,34	183,0	1F	24,0	80,0	120,0	102,0	117,0
40	178,25	188,0	1F	24,0	90,0	135,0	102,0	117,0
44	196,08	211,0	1F	24,0	90,0	135,0	102,0	117,0
48	213,90	226,0	7F	24,0	90,0	150,0	102,0	117,0
56	249,55	256,0	7F	28,0	90,0	150,0	102,0	117,0
64	285,21	296,0	7F	28,0	90,0	150,0	102,0	117,0
72	320,86	-	3	28,0	90,0	150,0	102,0	117,0
80	356,51	-	3	28,0	90,0	150,0	102,0	117,0
90	401,07	-	3	28,0	90,0	150,0	102,0	117,0
112	499,11	-	3	28,0	90,0	150,0	102,0	117,0
144	641,71	-	3	28,0	90,0	150,0	102,0	117,0
168	748,66	-	3	28,0	90,0	150,0	102,0	117,0
192	855,62	-	3	28,0	100,0	165,0	102,0	117,0
216	962,57	-	3	28,0	100,0	165,0	102,0	117,0

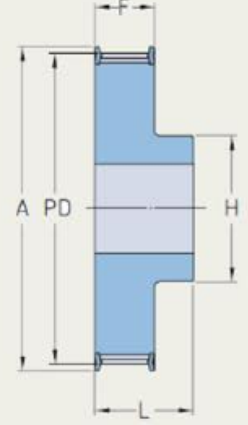

TİP 1F

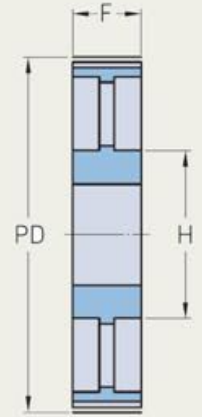

TİP 3

14M115

14M115 Kayış Geniřlięi 115 mm Belt Width 115 mm								
DİŐ SAYISI Number	ÇAP Diameter		TİP Type	DELİK Bore		BOYUTLAR Dimensions		
	PD.	A		Min.	Max.	H	F	L
	mm	mm		mm	mm	mm	mm	mm
28	124,78	127,0	1F	32,0	67,0	100,0	133,0	148,0
29	129,23	138,0	1F	32,0	67,0	100,0	133,0	148,0
30	133,69	138,0	1F	32,0	67,0	100,0	133,0	148,0
32	142,60	154,0	1F	32,0	67,0	100,0	133,0	148,0
34	151,52	160,0	1F	32,0	67,0	100,0	133,0	148,0
36	160,43	168,0	1F	32,0	67,0	100,0	133,0	148,0
38	169,34	183,0	1F	32,0	80,0	120,0	133,0	148,0
40	178,25	188,0	1F	32,0	90,0	135,0	133,0	148,0
44	196,08	211,0	1F	32,0	90,0	135,0	133,0	148,0
48	213,90	226,0	1F	32,0	100,0	150,0	133,0	148,0
56	249,55	256,0	1F	32,0	100,0	150,0	133,0	148,0
64	285,21	296,0	7F	32,0	90,0	150,0	133,0	148,0
72	320,86	-	3	32,0	90,0	150,0	133,0	148,0
80	356,51	-	3	32,0	90,0	150,0	133,0	148,0
90	401,07	-	3	32,0	90,0	150,0	133,0	148,0
112	499,11	-	3	32,0	90,0	150,0	133,0	148,0
144	641,71	-	3	32,0	100,0	150,0	133,0	148,0
168	748,66	-	3	32,0	100,0	150,0	133,0	148,0
192	855,62	-	3	32,0	100,0	165,0	133,0	148,0
216	962,57	-	3	32,0	100,0	165,0	133,0	148,0

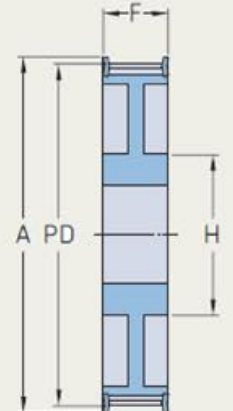

TİP 7F

PİLOT DELİKLİ / Pilot Bore

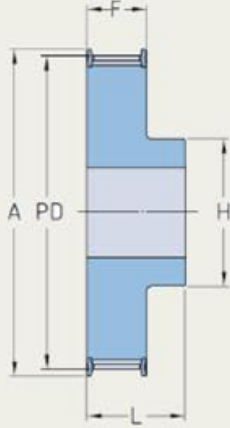

TİP 1F

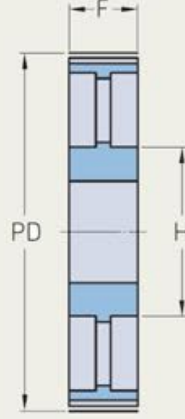

TİP 3

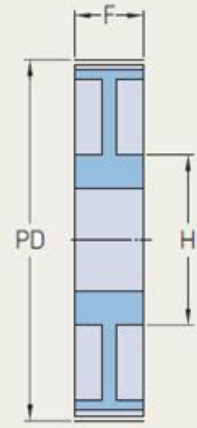

TİP 7

14M170

14M170 Kayış Geniřliđi 170 mm Belt Width 170 mm								
Dİř SAYISI Number	ÇAP Diameter		TİP Type	DELİK Bore		BOYUTLAR Dimensions		
	PD.	A		Min.	Max.	H	F	L
	mm	mm		mm	mm	mm	mm	mm
28	124,78	127,0	1F	32,0	67,0	100,0	187,0	202,0
29	129,23	138,0	1F	32,0	67,0	100,0	187,0	202,0
30	133,69	138,0	1F	32,0	67,0	100,0	187,0	202,0
32	142,60	154,0	1F	32,0	67,0	100,0	187,0	202,0
34	151,52	160,0	1F	32,0	67,0	100,0	187,0	202,0
36	160,43	168,0	1F	32,0	67,0	120,0	187,0	202,0
38	169,34	183,0	1F	32,0	80,0	135,0	187,0	202,0
40	178,25	188,0	1F	32,0	90,0	140,0	187,0	202,0
44	196,08	211,0	1F	32,0	94,0	160,0	187,0	202,0
48	213,90	226,0	1F	32,0	107,0	160,0	187,0	202,0
56	249,55	256,0	1F	32,0	110,0	160,0	187,0	202,0
64	285,21	296,0	1F	32,0	120,0	180,0	187,0	202,0
72	320,86	-	7	32,0	120,0	180,0	187,0	202,0
80	356,51	-	7	32,0	108,0	180,0	187,0	202,0
90	401,07	-	3	38,0	108,0	180,0	187,0	202,0
112	499,11	-	3	38,0	108,0	200,0	187,0	202,0
144	641,71	-	3	38,0	108,0	220,0	187,0	202,0
168	748,66	-	3	38,0	108,0	220,0	187,0	202,0
192	855,62	-	3	38,0	108,0	220,0	187,0	202,0
216	962,57	-	3	38,0	108,0	220,0	187,0	202,0

KONİK BURÇLU / With Taper Bushes



TIP 3F

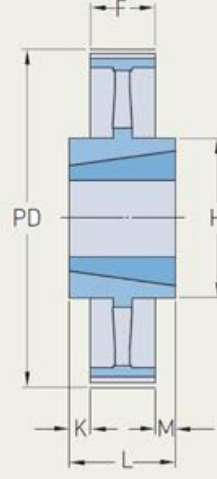

TIP 10

5M15

5M15		Kayış Geniřlięi 15 mm Belt Width 15 mm									
DİŐ SAYISI Number	ÇAP Diameter		TİP Type	KONİK BURÇ Bushes	DELİK Bore		BOYUTLAR Dimensions				
	PD. mm	A mm			Min. mm	Max. mm	H mm	K mm	F mm	M mm	L mm
34	54,11	58,0	3F	1008	9,0	25,0	43,0	-	20,5	1,5	22,0
36	57,30	61,0	3F	1108	9,0	28,0	45,0	-	20,5	1,5	22,0
38	60,48	65,0	3F	1108	9,0	28,0	48,0	-	20,5	1,5	22,0
40	63,66	68,0	3F	1108	9,0	28,0	52,0	-	20,5	1,5	22,0
44	70,03	74,0	3F	1108	9,0	28,0	54,0	-	20,5	1,5	22,0
48	76,39	80,0	3F	1210	12,0	30,0	64,0	-	20,5	4,5	25,0
56	89,13	93,0	3F	1210	12,0	30,0	70,0	-	20,5	4,5	25,0
64	101,86	106,0	3F	1210	12,0	30,0	78,0	-	20,5	4,5	25,0
72	114,59	118,0	3F	1610	14,0	40,0	90,0	-	20,5	4,5	25,0
80	127,32	135,0	3F	1610	14,0	40,0	92,0	-	20,5	4,5	25,0
90	143,24	-	10	1610	14,0	40,0	92,0	2,3	20,5	2,3	25,0
112	178,25	-	10	1610	14,0	40,0	92,0	2,3	20,5	2,3	25,0
136	216,45	-	10	2012	18,0	50,0	106,0	5,8	20,5	5,8	32,0
150	238,73	-	10	2012	18,0	50,0	106,0	5,8	20,5	5,8	32,0

KONİK BURÇLU / With Taper Bushes

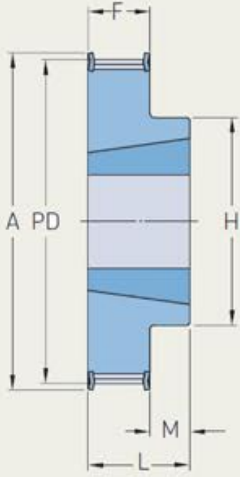

TIP 3F

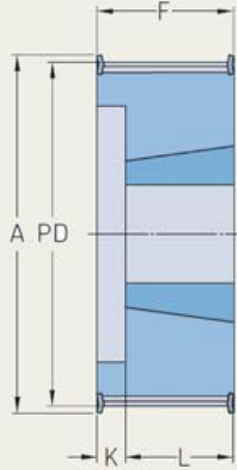

TIP 4F

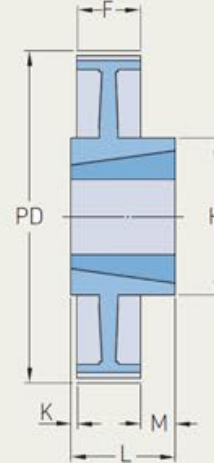

TIP 12

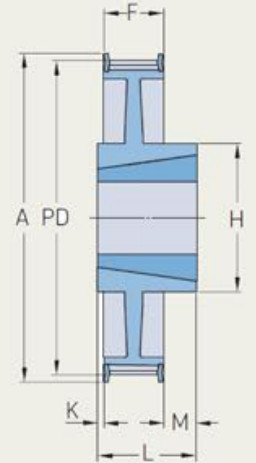

TIP 12F

8M20

8M20		Kayış Geniřlięi 20 mm Belt Width 20 mm									
DİŐ SAYISI Number	ÇAP Diameter		TİP Type	KONİK BURÇ Bushes	DELİK Bore		BOYUTLAR Dimensions				
	PD.	A			Min.	Max.	H	K	F	M	L
	mm	mm			mm	mm	mm	mm	mm	mm	mm
22	56,02	65,0	4F	1008	9,0	25,0	-	6,0	28,0	-	22,0
24	61,12	70,0	4F	1108	9,0	28,0	-	6,0	28,0	-	22,0
26	66,21	75,0	4F	1108	9,0	28,0	-	6,0	28,0	-	22,0
28	71,30	80,0	4F	1108	9,0	28,0	-	6,0	28,0	-	22,0
30	76,39	85,0	4F	1108	9,0	28,0	-	3,0	28,0	-	22,0
32	81,49	90,0	4F	1610	14,0	40,0	-	3,0	28,0	-	25,0
34	86,58	95,0	4F	1610	14,0	40,0	-	3,0	28,0	-	25,0
36	91,67	100,0	4F	1610	14,0	40,0	-	3,0	28,0	-	25,0
38	96,77	105,0	4F	1610	14,0	40,0	-	3,0	28,0	-	25,0
40	101,86	110,0	4F	1610	14,0	40,0	-	3,0	28,0	-	25,0
42	106,95	111,0	4F	1610	14,0	40,0	-	3,0	28,0	-	25,0
44	112,05	121,0	3F	2012	18,0	50,0	92,0	-	28,0	4,0	32,0
48	122,23	131,0	3F	2012	18,0	50,0	96,0	-	28,0	4,0	32,0
56	142,60	151,0	3F	2012	18,0	50,0	110,0	-	28,0	4,0	32,0
60	152,79	162,0	3F	2012	18,0	50,0	110,0	-	28,0	4,0	32,0
64	162,97	172,0	12F	2012	18,0	50,0	110,0	-	28,0	4,0	32,0
72	183,35	192,0	12F	2012	18,0	50,0	110,0	-	28,0	4,0	32,0
80	203,72	-	12	2517	20,0	60,0	125,0	-	28,0	17,0	45,0
90	229,18	-	12	2517	20,0	60,0	125,0	-	28,0	17,0	45,0

KONİK BURÇLU / With Taper Bushes

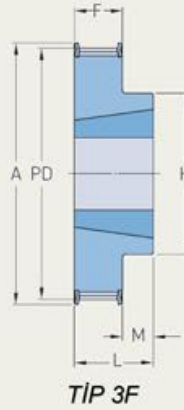
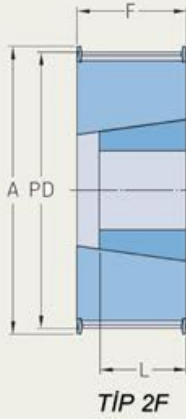

8M30

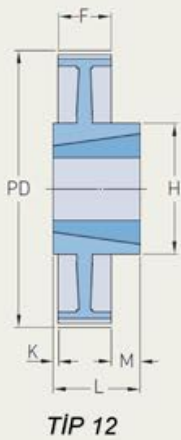
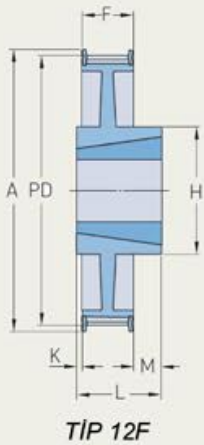

8M30		Kayış Geniřliđi 30 mm Belt Width 30 mm									
DİŐ SAYISI Number	ÇAP Diameter		TİP Type	KONİK BURÇ Bushes	DELİK Bore		BOYUTLAR Dimensions				
	PD. mm	A mm			Min. mm	Max. mm	H mm	K mm	F mm	M mm	L mm
20	50,93	60,0	4F	1008	9,0	25,0	-	16,0	38,0	-	22,0
21	53,47	62,0	4F	1008	9,0	25,0	-	16,0	38,0	-	22,0
22	56,02	65,0	4F	1008	9,0	25,0	-	16,0	38,0	-	22,0
23	58,57	65,0	4F	1108	9,0	28,0	-	16,0	38,0	-	22,0
24	61,12	70,0	4F	1108	9,0	28,0	-	16,0	38,0	-	22,0
25	63,66	71,0	4F	1108	9,0	28,0	-	16,0	38,0	-	22,0
26	66,21	75,0	4F	1108	9,0	28,0	-	16,0	38,0	-	22,0
27	68,75	75,0	4F	1108	9,0	28,0	-	16,0	38,0	-	22,0
28	71,30	80,0	4F	1210	12,0	30,0	-	13,0	38,0	-	25,0
30	76,39	85,0	2F	1615	14,0	40,0	-	-	38,0	-	38,0
31	78,94	87,0	2F	1615	14,0	40,0	-	-	38,0	-	38,0
32	81,49	90,0	2F	1615	14,0	40,0	-	-	38,0	-	38,0
33	84,03	90,0	2F	1615	14,0	40,0	-	-	38,0	-	38,0
34	86,58	95,0	2F	1615	14,0	40,0	-	-	38,0	-	38,0
35	89,13	100,0	2F	1615	14,0	40,0	-	-	38,0	-	38,0
36	91,67	100,0	2F	1615	14,0	40,0	-	-	38,0	-	38,0
38	96,77	106,0	2F	1615	14,0	40,0	-	-	38,0	-	38,0
40	101,86	110,0	2F	1615	14,0	40,0	-	-	38,0	-	38,0
42	106,95	121,0	2F	1615	14,0	40,0	-	-	38,0	-	38,0
44	112,05	121,0	6F	2012	18,0	50,0	-	3,0	38,0	3,0	32,0
45	114,59	131,0	6F	2012	18,0	50,0	-	3,0	38,0	3,0	32,0
48	122,23	136,0	6F	2012	18,0	50,0	-	3,0	38,0	3,0	32,0
50	127,32	141,0	6F	2012	18,0	50,0	-	3,0	38,0	3,0	32,0
52	132,42	151,0	6F	2012	18,0	50,0	-	3,0	38,0	3,0	32,0
56	142,60	156,0	6F	2012	18,0	50,0	-	3,0	38,0	3,0	32,0
60	152,79	162,0	3F	2517	20,0	60,0	125,0	-	38,0	7,0	45,0
64	162,97	171,0	3F	2517	20,0	60,0	125,0	-	38,0	7,0	45,0
72	183,35	192,0	12F	2517	20,0	60,0	125,0	-	38,0	7,0	45,0
80	203,72	-	12	2517	20,0	60,0	125,0	-	38,0	7,0	45,0
90	229,18	-	12	2517	20,0	60,0	125,0	-	38,0	7,0	45,0
112	285,21	-	12	2517	20,0	60,0	125,0	-	38,0	7,0	45,0
144	366,69	-	12	2517	20,0	60,0	125,0	-	38,0	7,0	45,0
168	427,81	-	10	3020	25,0	75,0	170,0	6,5	38,0	6,5	51,0
192	488,92	-	10	3525	35,0	90,0	198,0	13,0	38,0	13,0	64,0

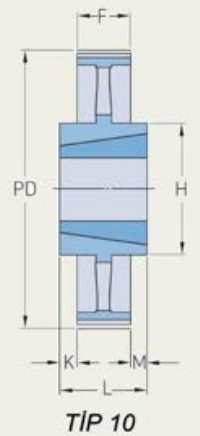
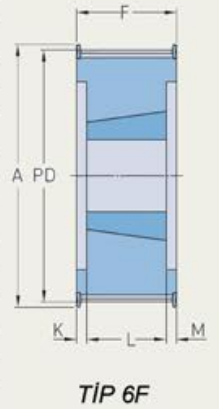

KONİK BURÇLU / With Taper Bushes



TIP 4F

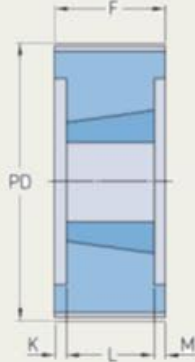

TIP 6

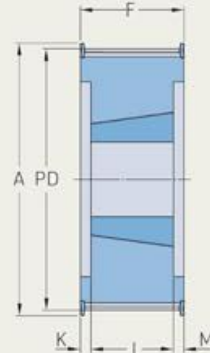

TIP 6F

8M50

8M50		Kayış Geniřliđi 50 mm Belt Width 50 mm									
Diř SAYISI Number	ÇAP Diameter		TİP Type	KONİK BURÇ Bushes	DELİK Bore		BOYUTLAR Dimensions				
	PD. mm	A mm			Min. mm	Max. mm	H mm	K mm	F mm	M mm	L mm
24	61,12	70,0	6F	1108	9,0	28,0	-	19,0	60,0	19,0	22,0
26	66,21	75,0	6F	1108	9,0	28,0	-	19,0	60,0	19,0	22,0
27	68,75	75,0	6F	1108	9,0	28,0	-	19,0	60,0	19,0	22,0
28	71,30	80,0	4F	1210	12,0	30,0	-	35,0	60,0	-	25,0
30	76,39	85,0	4F	1615	14,0	40,0	-	22,0	60,0	-	38,0
31	78,94	87,0	4F	1615	14,0	40,0	-	22,0	60,0	-	38,0
32	81,49	90,0	4F	1615	14,0	40,0	-	22,0	60,0	-	38,0
33	84,03	90,0	4F	1615	14,0	40,0	-	22,0	60,0	-	38,0
34	86,58	95,0	4F	1615	14,0	40,0	-	22,0	60,0	-	38,0
35	89,13	95,0	4F	1615	14,0	40,0	-	22,0	60,0	-	38,0
36	91,67	100,0	4F	1615	14,0	40,0	-	22,0	60,0	-	38,0
38	96,77	105,0	4F	2012	18,0	50,0	-	28,0	60,0	-	32,0
40	101,86	110,0	4F	2012	18,0	50,0	-	28,0	60,0	-	32,0
42	106,95	111,0	4F	2012	18,0	50,0	-	28,0	60,0	-	32,0
44	112,05	121,0	6F	2012	18,0	50,0	-	14,0	60,0	14,0	32,0
45	114,59	121,0	6F	2012	18,0	50,0	-	14,0	60,0	14,0	32,0
48	122,23	131,0	6F	2012	18,0	50,0	-	14,0	60,0	14,0	32,0
50	127,32	131,0	6F	2012	18,0	50,0	-	14,0	60,0	14,0	32,0
52	132,42	140,0	6F	2012	18,0	50,0	-	14,0	60,0	14,0	32,0
56	142,60	151,0	6F	2517	20,0	60,0	-	7,5	60,0	7,5	45,0
60	152,79	158,0	6F	2517	20,0	60,0	-	7,5	60,0	7,5	45,0
64	162,97	172,0	6F	2517	20,0	60,0	-	7,5	60,0	7,5	45,0
72	183,35	192,0	7F	2517	20,0	60,0	125,0	7,5	60,0	7,5	45,0
80	203,72	-	7	3020	25,0	75,0	150,0	4,5	60,0	4,5	51,0
90	229,18	-	7	3020	25,0	75,0	150,0	4,5	60,0	4,5	51,0
112	285,21	-	7	3020	25,0	75,0	150,0	4,5	60,0	4,5	51,0
144	366,69	-	8	3020	25,0	75,0	150,0	4,5	60,0	4,5	51,0
168	427,81	-	10	3525	35,0	90,0	170,0	2,0	60,0	2,0	64,0
192	488,92	-	10	3525	35,0	90,0	170,0	2,0	60,0	2,0	64,0

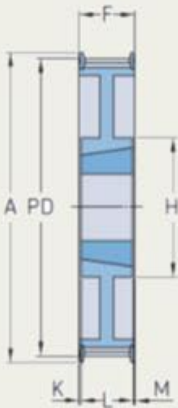

TIP 7F

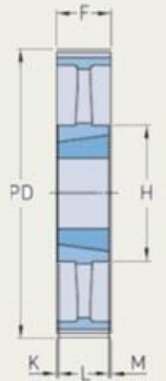

TIP 8

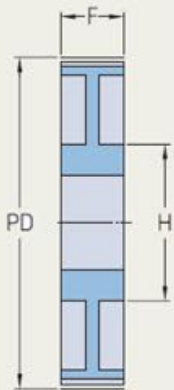

TIP 7

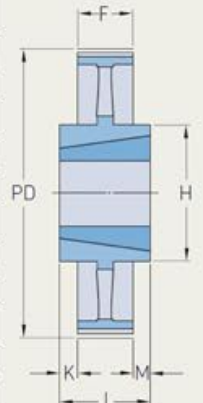

TIP 10

KONİK BURÇLU / With Taper Bushes

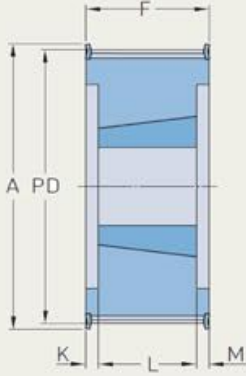

TIP 6F

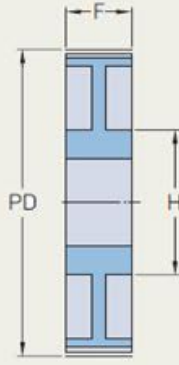

TIP 7



TIP 7F

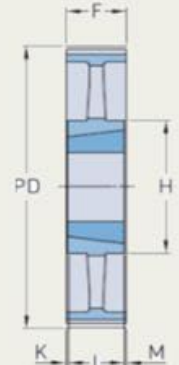

TIP 8

8M85

8M85		Kayış Geniřliđi 85 mm Belt Width 85 mm									
DİŐ SAYISI Number	ÇAP Diameter		TİP Type	KONİK BURÇ Bushes	DELİK Bore		BOYUTLAR Dimensions				
	PD. mm	A mm			Min. mm	Max. mm	H mm	K mm	F mm	M mm	L mm
24	61,12	70,0	6F	1108	9,0	28,0	-	36,5	95,0	36,5	22,0
26	66,21	75,0	6F	1108	9,0	28,0	-	36,5	95,0	36,5	22,0
27	68,75	75,0	6F	1108	9,0	28,0	-	36,5	95,0	36,5	22,0
28	71,30	80,0	6F	1108	9,0	28,0	-	36,5	95,0	36,5	22,0
30	76,39	85,0	6F	1615	14,0	40,0	-	28,5	95,0	28,5	38,0
31	78,94	87,0	6F	1615	14,0	40,0	-	28,5	95,0	28,5	38,0
32	81,49	90,0	6F	1615	14,0	40,0	-	28,5	95,0	28,5	38,0
33	84,03	90,0	6F	1615	14,0	40,0	-	28,5	95,0	28,5	38,0
34	86,58	95,0	6F	1615	14,0	40,0	-	28,5	95,0	28,5	38,0
35	89,13	95,0	6F	1615	14,0	40,0	-	28,5	95,0	28,5	38,0
36	91,67	100,0	6F	1615	14,0	40,0	-	28,5	95,0	28,5	38,0
38	96,77	105,0	6F	1615	14,0	40,0	-	28,5	95,0	28,5	38,0
40	101,86	110,0	6F	2012	18,0	50,0	-	31,5	95,0	31,5	32,0
42	106,95	111,0	6F	2012	18,0	50,0	-	31,5	95,0	31,5	32,0
44	112,05	121,0	6F	2012	18,0	50,0	-	31,5	95,0	31,5	32,0
45	114,59	121,0	6F	2012	18,0	50,0	-	31,5	95,0	31,5	32,0
48	122,23	131,0	6F	2517	20,0	60,0	-	25,0	95,0	25,0	45,0
50	127,32	131,0	6F	2517	20,0	60,0	-	25,0	95,0	25,0	45,0
52	132,42	140,0	6F	2517	20,0	60,0	-	25,0	95,0	25,0	45,0
56	142,60	151,0	6F	2517	20,0	60,0	-	25,0	95,0	25,0	45,0
60	152,79	158,0	6F	2517	20,0	60,0	-	25,0	95,0	25,0	45,0
64	162,97	172,0	7F	2517	20,0	60,0	125,0	25,0	95,0	25,0	45,0
72	183,35	-	7	3020	25,0	75,0	170,0	22,0	95,0	22,0	51,0
80	203,72	-	8	3020	25,0	75,0	170,0	22,0	95,0	22,0	51,0
90	229,18	-	8	3020	25,0	75,0	170,0	22,0	95,0	22,0	51,0
112	285,21	-	8	3020	25,0	75,0	170,0	22,0	95,0	22,0	51,0
144	366,69	-	8	3535	35,0	90,0	190,0	3,0	95,0	3,0	89,0
168	427,81	-	8	3535	35,0	90,0	190,0	3,0	95,0	3,0	89,0
192	488,92	-	8	3535	35,0	90,0	190,0	3,0	95,0	3,0	89,0

KONİK BURÇLU / With Taper Bushes

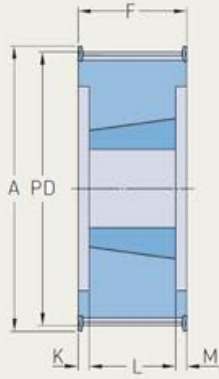

TIP 6F



TIP 7



TIP 7F

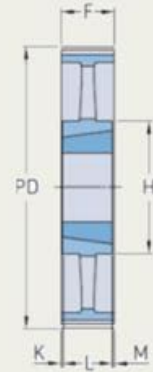

TIP 8

14M40

14M40 Kayış Geniřlięi 40 mm Belt Width 40 mm											
Diř SAYISI Number	ÇAP Diameter		TİP Type	KONİK BURÇ Bushes	DELİK Bore		BOYUTLAR Dimensions				
	PD.	A			Min.	Max.	H	K	F	M	L
	mm	mm			mm	mm	mm	mm	mm	mm	mm
28	124,78	127,0	6F	2012	18,0	50,0	-	11,0	54,0	11,0	32,0
29	129,23	138,0	6F	2012	18,0	50,0	-	11,0	54,0	11,0	32,0
30	133,69	138,0	6F	2012	18,0	50,0	-	11,0	54,0	11,0	32,0
32	142,60	154,0	6F	2012	18,0	50,0	-	11,0	54,0	11,0	32,0
34	151,52	160,0	6F	2517	20,0	60,0	-	4,5	54,0	4,5	45,0
36	160,43	168,0	6F	2517	20,0	60,0	-	4,5	54,0	4,5	45,0
38	169,34	183,0	6F	2517	20,0	60,0	-	4,5	54,0	4,5	45,0
40	178,25	188,0	6F	2517	20,0	60,0	-	4,5	54,0	4,5	45,0
44	196,08	211,0	6F	2517	20,0	60,0	-	4,5	54,0	4,5	45,0
48	213,90	226,0	6F	2517	20,0	60,0	-	4,5	54,0	4,5	45,0
56	249,55	256,0	6F	3020	25,0	75,0	-	1,5	54,0	1,5	51,0
60	267,38	281,0	7F	3020	25,0	75,0	170,0	1,5	54,0	1,5	51,0
64	285,21	296,0	7F	3020	25,0	75,0	170,0	1,5	54,0	1,5	51,0
72	320,86	-	7	3020	25,0	75,0	170,0	1,5	54,0	1,5	51,0
80	356,51	-	8	3020	25,0	75,0	170,0	1,5	54,0	1,5	51,0
90	401,07	-	8	3020	25,0	75,0	170,0	1,5	54,0	1,5	51,0
112	499,11	-	8	3020	25,0	75,0	170,0	1,5	54,0	1,5	51,0
144	641,71	-	8	3020	25,0	75,0	170,0	1,5	54,0	1,5	51,0
168	748,66	-	8	3020	25,0	75,0	170,0	1,5	54,0	1,5	51,0
192	855,62	-	8	3020	25,0	75,0	170,0	1,5	54,0	1,5	51,0
216	962,57	-	8	3020	25,0	75,0	170,0	1,5	54,0	1,5	51,0

KONİK BURÇLU / With Taper Bushes

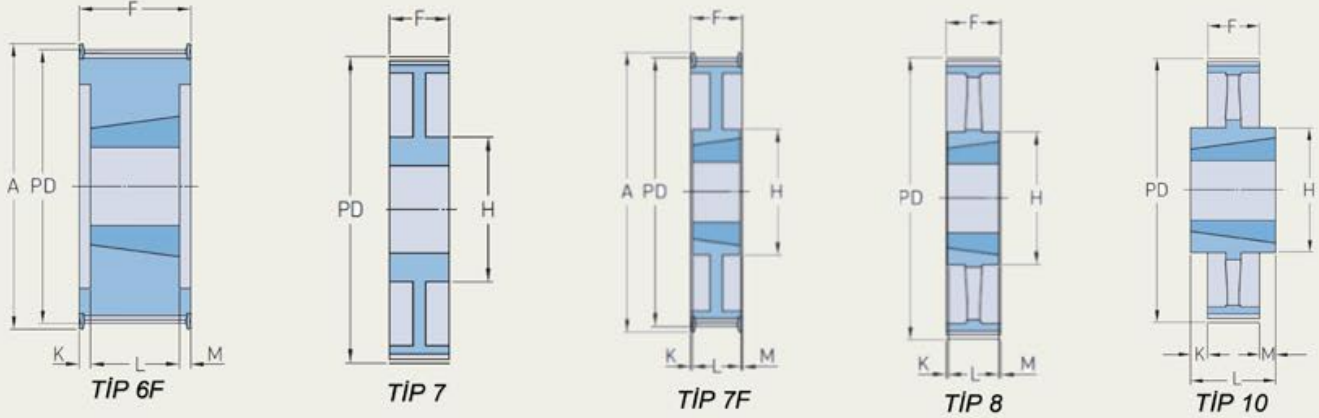

14M55

14M55 Kayış Geniřlięi 55 mm Belt Width 55 mm											
DIŐ SAYISI Number	ÇAP Diameter		TİP Type	KONİK BURÇ Bushes	DELİK Bore		BOYUTLAR Dimensions				
	PD.	A			Min.	Max.	H	K	F	M	L
	mm	mm			mm	mm	mm	mm	mm	mm	mm
28	124,78	127,0	6F	2012	18,0	50,0	-	19,0	70,0	19,0	32,0
29	129,23	138,0	6F	2012	18,0	50,0	-	19,0	70,0	19,0	32,0
30	133,69	138,0	6F	2517	20,0	60,0	-	12,5	70,0	12,5	45,0
32	142,60	154,0	6F	2517	20,0	60,0	-	12,5	70,0	12,5	45,0
34	151,52	160,0	6F	2517	20,0	60,0	-	12,5	70,0	12,5	45,0
36	160,43	168,0	6F	2517	20,0	60,0	-	12,5	70,0	12,5	45,0
38	169,34	183,0	6F	2517	20,0	60,0	-	12,5	70,0	12,5	45,0
40	178,25	188,0	6F	2517	20,0	60,0	-	12,5	70,0	12,5	45,0
42	187,17	209,0	6F	3020	25,0	75,0	-	9,5	70,0	9,5	51,0
44	196,08	211,0	6F	3020	25,0	75,0	-	9,5	70,0	9,5	51,0
48	213,90	226,0	6F	3020	25,0	75,0	-	9,5	70,0	9,5	51,0
56	249,55	256,0	6F	3020	25,0	75,0	-	9,5	70,0	9,5	51,0
60	267,38	281,0	7F	3020	25,0	75,0	170,0	9,5	70,0	9,5	51,0
64	285,21	296,0	7F	3020	25,0	75,0	170,0	9,5	70,0	9,5	51,0
72	320,86	-	7	3020	25,0	75,0	170,0	9,5	70,0	9,5	51,0
80	356,51	-	8	3020	25,0	75,0	170,0	9,5	70,0	9,5	51,0
90	401,07	-	8	3020	25,0	75,0	170,0	9,5	70,0	9,5	51,0
112	499,11	-	8	3020	25,0	75,0	170,0	9,5	70,0	9,5	51,0
144	641,71	-	8	3020	25,0	75,0	170,0	9,5	70,0	9,5	51,0
168	748,66	-	8	3020	25,0	75,0	170,0	9,5	70,0	9,5	51,0
192	855,62	-	8	3020	25,0	75,0	170,0	9,5	70,0	9,5	51,0
216	962,57	-	10	3535	35,0	90,0	170,0	9,5	70,0	9,5	89,0

KONİK BURÇLU / With Taper Bushes

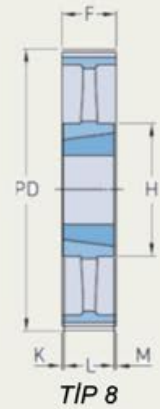
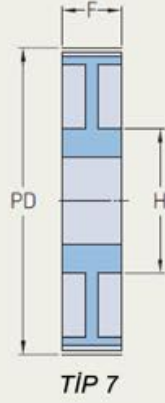
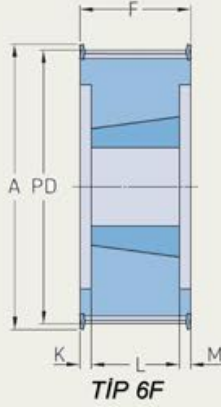

14M85

14M85 Kayış Geniřlięi 85 mm Belt Width 85 mm											
DİŐ SAYISI Number	ÇAP Diameter		TİP Type	KONİK BURÇ Bushes	DELİK Bore		BOYUTLAR Dimensions				
	PD. mm	A mm			Min. mm	Max. mm	H mm	K mm	F mm	M mm	L mm
28	124,78	127,0	6F	2517	20,0	60,0	-	28,5	102,0	28,5	45,0
29	129,23	138,0	6F	2517	20,0	60,0	-	28,5	102,0	28,5	45,0
30	133,69	138,0	6F	2517	20,0	60,0	-	28,5	102,0	28,5	45,0
32	142,60	154,0	6F	2517	20,0	60,0	-	28,5	102,0	28,5	45,0
34	151,52	160,0	6F	2517	20,0	60,0	-	28,5	102,0	28,5	45,0
36	160,43	168,0	6F	3020	25,0	75,0	-	25,5	102,0	25,5	51,0
38	169,34	183,0	6F	3020	25,0	75,0	-	25,5	102,0	25,5	51,0
40	178,25	188,0	6F	3020	25,0	75,0	-	25,5	102,0	25,5	51,0
44	196,08	211,0	6F	3020	25,0	75,0	-	25,5	102,0	25,5	51,0
48	213,90	226,0	6F	3020	25,0	75,0	-	25,5	102,0	25,5	51,0
56	249,55	256,0	6F	3535	35,0	90,0	-	6,5	102,0	6,5	89,0
60	267,38	281,0	6F	3535	35,0	90,0	-	6,5	102,0	6,5	89,0
64	285,21	296,0	7F	3535	35,0	90,0	190,0	6,5	102,0	6,5	89,0
72	320,86	-	7	3535	35,0	90,0	190,0	6,5	102,0	6,5	89,0
80	356,51	-	7	3535	35,0	90,0	190,0	6,5	102,0	6,5	89,0
90	401,07	-	7	3535	35,0	90,0	190,0	6,5	102,0	6,5	89,0
112	499,11	-	7	3535	35,0	90,0	190,0	6,5	102,0	6,5	89,0
144	641,71	-	7	3535	40,0	100,0	190,0	6,5	102,0	6,5	89,0
168	748,66	-	7	3535	40,0	100,0	190,0	6,5	102,0	6,5	89,0
192	855,62	-	8	4040	40,0	100,0	230,0	-	102,0	-	102,0
216	962,57	-	8	4040	40,0	100,0	230,0	-	102,0	-	102,0

KONİK BURÇLU / With Taper Bushes

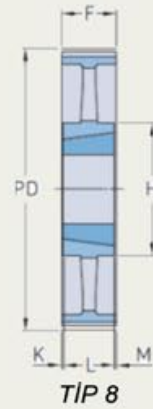
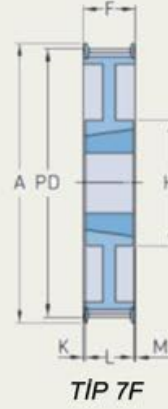
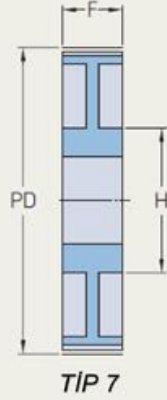
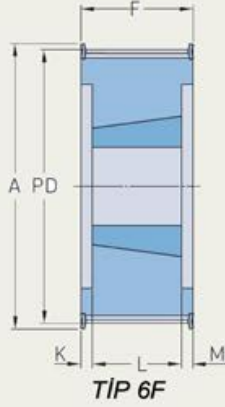

14M115

14M115 Kayış Geniřlięi 115 mm Belt Width 115 mm											
DİŐ SAYISI Number	ÇAP Diameter		TİP Type	KONİK BURÇ Bushes	DELİK Bore		BOYUTLAR Dimensions				
	PD.	A			Min.	Max.	H	K	F	M	L
	mm	mm			mm	mm	mm	mm	mm	mm	mm
28	124,78	127,0	6F	2517	20,0	60,0	-	44,0	133,0	44,0	45,0
29	129,23	138,0	6F	2517	20,0	60,0	-	44,0	133,0	44,0	45,0
30	133,69	138,0	6F	2517	20,0	60,0	-	44,0	133,0	44,0	45,0
32	142,60	154,0	6F	2517	20,0	60,0	-	44,0	133,0	44,0	45,0
34	151,52	160,0	6F	2517	20,0	60,0	-	44,0	133,0	44,0	45,0
36	160,43	168,0	6F	3020	25,0	75,0	-	41,0	133,0	41,0	51,0
38	169,34	183,0	6F	3020	25,0	75,0	-	41,0	133,0	41,0	51,0
40	178,25	188,0	6F	3020	25,0	75,0	-	41,0	133,0	41,0	51,0
44	196,08	211,0	6F	3030	25,0	75,0	-	28,5	133,0	28,5	76,0
48	213,90	226,0	6F	3030	25,0	75,0	-	28,5	133,0	28,5	76,0
56	249,55	256,0	6F	3535	35,0	90,0	-	22,0	133,0	22,0	89,0
60	267,38	281,0	6F	3535	35,0	90,0	-	22,0	133,0	22,0	89,0
64	285,21	296,0	7F	3535	35,0	90,0	190,0	22,0	133,0	22,0	89,0
72	320,86	-	7F	3535	35,0	90,0	190,0	22,0	133,0	22,0	89,0
80	356,51	-	7	3535	35,0	90,0	190,0	22,0	133,0	22,0	89,0
90	401,07	-	7	3535	35,0	90,0	190,0	22,0	133,0	22,0	89,0
112	499,11	-	7	3535	35,0	90,0	190,0	22,0	133,0	22,0	89,0
144	641,71	-	8	4040	40,0	100,0	230,0	15,5	133,0	15,5	102,0
168	748,66	-	8	4040	40,0	100,0	230,0	15,5	133,0	15,5	102,0
192	855,62	-	8	4040	40,0	100,0	230,0	15,5	133,0	15,5	102,0
216	962,57	-	8	4040	40,0	100,0	230,0	15,5	133,0	15,5	102,0

KONİK BURÇLU / With Taper Bushes

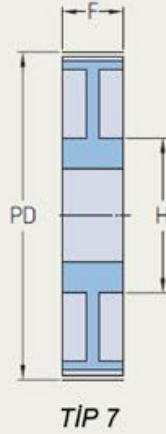
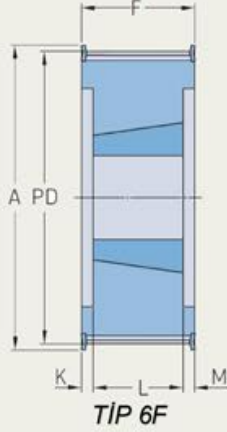

14M170

14M170 Kayış Geniřlięi 170 mm Belt Width 170 mm											
DİŐ SAYISI Number	ÇAP Diameter		TİP Type	KONİK BURÇ Bushes	DELİK Bore		BOYUTLAR Dimensions				
	PD.	A			Min.	Max.	H	K	F	M	L
	mm	mm			mm	mm	mm	mm	mm	mm	mm
35	155,97	173,0	6F	3030	25,0	75,0	100,0	55,5	187,0	55,5	76,0
36	160,43	173,0	6F	3030	25,0	75,0	120,0	55,5	187,0	55,5	76,0
38	169,34	182,0	6F	3030	25,0	75,0	135,0	55,5	187,0	55,5	76,0
40	178,25	188,0	6F	3030	25,0	75,0	140,0	55,5	187,0	55,5	76,0
44	196,08	209,0	6F	3535	35,0	90,0	160,0	49,0	187,0	49,0	89,0
48	213,90	227,0	6F	3535	35,0	90,0	160,0	49,0	187,0	49,0	89,0
56	249,55	263,0	6F	3535	35,0	90,0	160,0	49,0	187,0	49,0	89,0
60	267,38	281,0	6F	4040	40,0	100,0	-	42,5	187,0	42,5	102,0
64	285,21	296,0	6F	4040	40,0	100,0	180,0	42,5	187,0	42,5	102,0
72	320,86	-	7	4040	40,0	100,0	180,0	42,5	187,0	42,5	102,0
80	356,51	-	7	4040	40,0	100,0	180,0	42,5	187,0	42,5	102,0
90	401,07	-	7	4040	40,0	100,0	180,0	42,5	187,0	42,5	102,0
112	499,11	-	7	5050	50,0	125,0	200,0	30,0	187,0	30,0	127,0
144	641,71	-	8	5050	50,0	125,0	220,0	30,0	187,0	30,0	127,0
168	748,66	-	8	5050	50,0	125,0	220,0	30,0	187,0	30,0	127,0
192	855,62	-	8	5050	50,0	125,0	220,0	30,0	187,0	30,0	127,0
216	962,57	-	8	5050	50,0	125,0	220,0	30,0	187,0	30,0	127,0

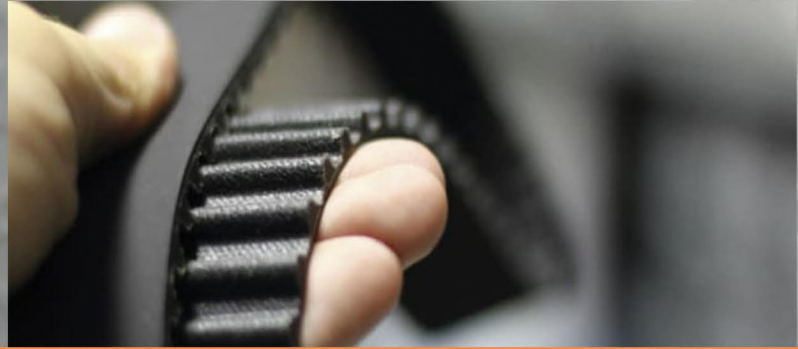

MGTORK GÜÇ VE HAREKET AKTARMA ELEMANLARI

FEVZİÇAKMAK MAH. KTM 10638 SOK. C1 BLOK NO:7E KARATAY / KONYA

TEL : +90 332 501 10 11 FAX: +90 332 501 10 12 info@mgtork.com

www.mgtork.com